

WDVOS

Series of types of roof fans with low operational noise level

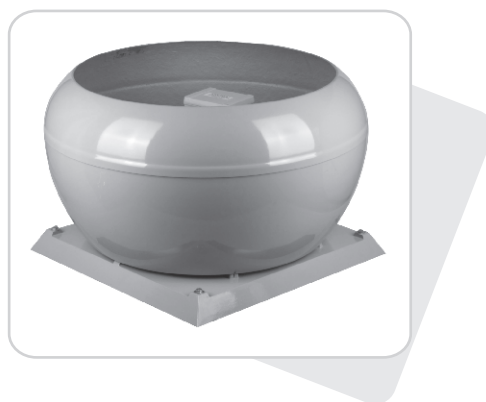

WDVOS roof fans with vertical air outflow are characterized by the modern design which was possible to achieve by making the casing elements out of plastic. The reliable long-year operation and unchanged fan appearance are guaranteed thanks to use high-duty fan and non-corrosive and mass dyed casing elements.

INTENDED USE

Roof fans with vertical air outflow are intended for removing the air from the production warehouses, storage warehouses, retail pavilions, shops, offices etc. Removed foul air can be polluted with the vapors and corrosive gases and the dust pollution within the limits permitted by the environment protection regulations.

DEVICE DESCRIPTION

Series of types of roof fans include 4 sizes.

Fans consist of:

- highly efficient steel centrifugal rotor with motor placed inside of the rotor,
- carrying plate made from polyester-glass laminate,
- shield made from polyester-glass laminate.

Fans are adapted for mounting them on the universal bases or on the damping universal bases.

WORKING CONDITIONS

Fans are supplied with the following motors:

- **single-phase** (for the sizes: 35 and 45) with the possibility of connecting to 5-speed revolutions governor
- **three phase** (for the sizes: 31,35, 40 and 45)

Permissible temperature of removed air is 50°C.

DESIGNATIONS

Roof fans	WDVOS - 25 - J
Size	31; 35; 40; 45
Motor type	single phase (J); three phase (TD)

WDVOS ROOF FANS

TECHNICAL DATA

Basic dimensions

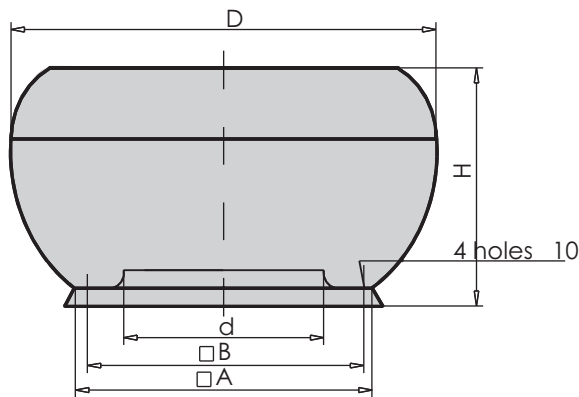

Fan size	d [mm]	D [mm]	A [mm]	B [mm]	H [mm]	Weight [kg]
WDVOS-31	203	807	605	480	465	20,5
WDVOS-35	228	807	605	480	465	24
WDVOS-40	257	927	675	560	560	28
WDVOS-45	297	927	675	560	560	32,5

Motor

RH31V-VDK.2C.1R
 3~400 V
 0,14/0,10 kW
 0,29/0,16 A
 1340/1090 rpm

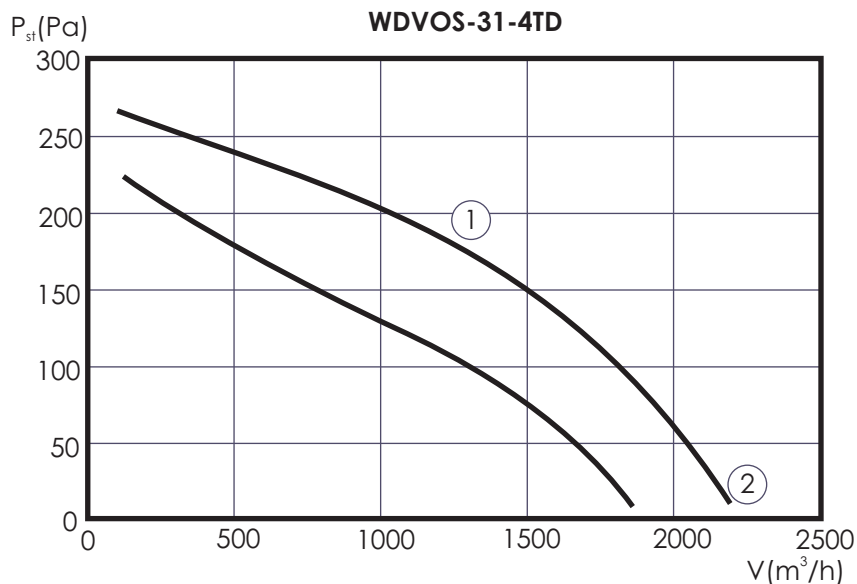

Motor

RH35V-4EK.4C.1R
 1~230 V
 0,27 kW
 1,3 A
 1390÷650 rpm
 5-step revolutions
 governor

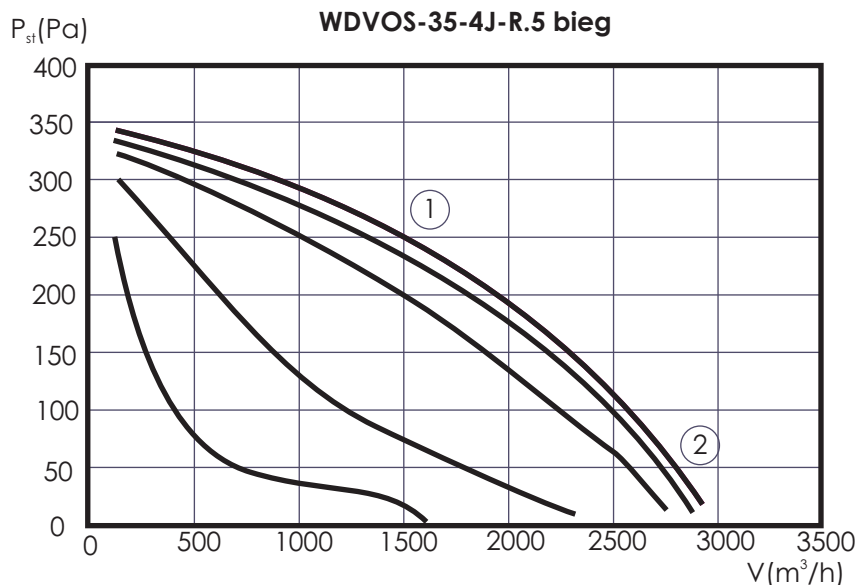

P_{st} –static negative pressure in the fan inlet

Motor

RH35V-VDK.4A.1R
 3~400 V
 0,24/0,16 kW
 0,47/0,27 A
 1340/1060 rpm

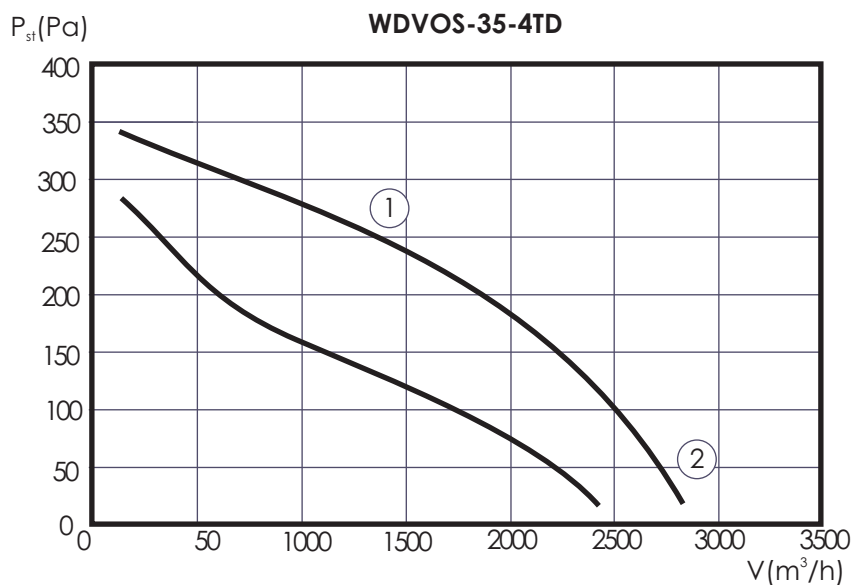

Motor

RH40V-VDK.4C.1R
 3~400 V
 0,44/0,31 kW
 0,77/0,50 A
 1320/1010 rpm

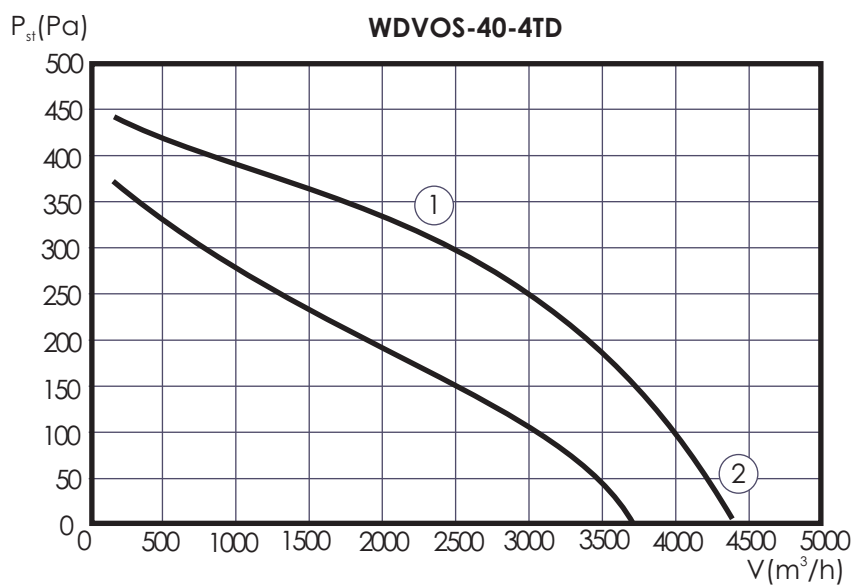

Motor

RH45V-4EK.4I.1R
 1~230 V
 0,62 kW
 2,8 A
 1230÷610 rpm
 5-step revolutions
 governor

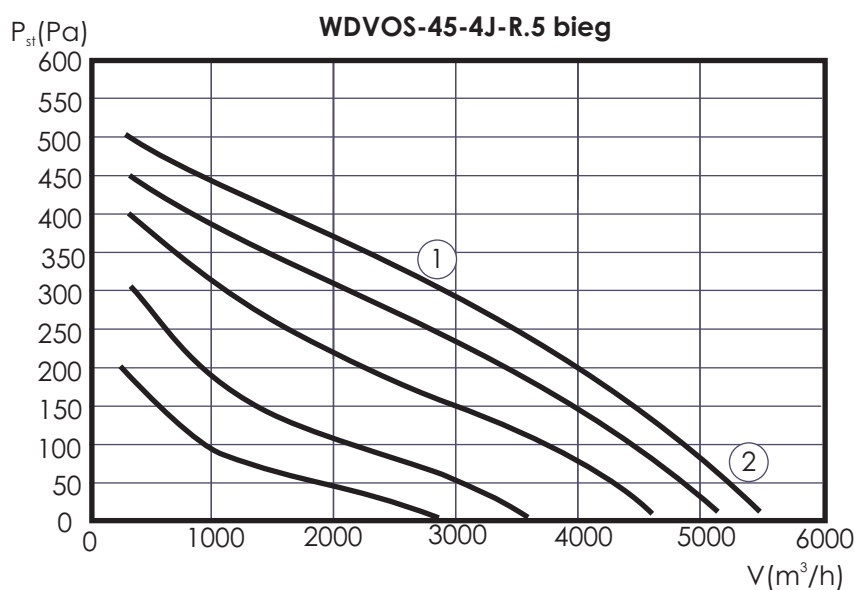

P_{st} –static negative pressure in the fan inlet

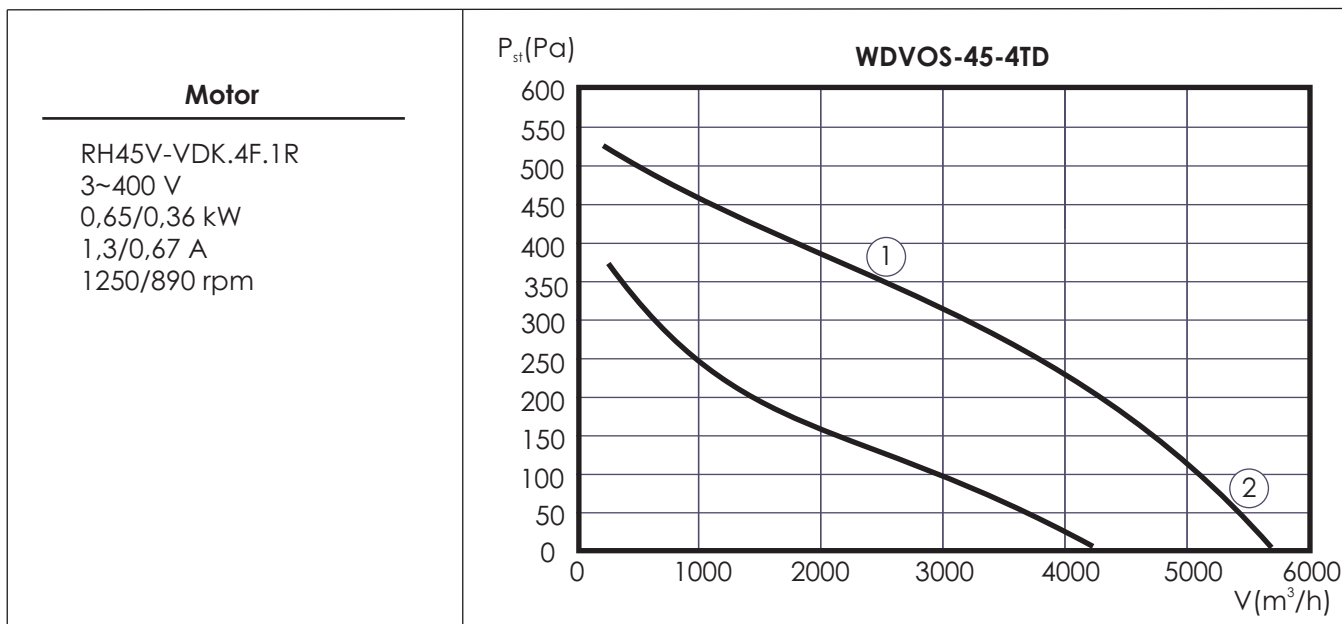

P_{st} –static negative pressure in the fan inlet

Operating noise level

Fan size	Operating noise level [dB(A)] of fans with single phase and three phase motors							
	at the air outlet side*				at the air inlet side**			
	at the point ①		at the point ②		at the point ①		at the point ②	
	at 1m dist.	at 5m dist.	at 1m dist.	at 5m dist.	at 1m dist.	at 5m dist.	at 1m dist.	at 5m dist.
WDVOS-31	53	41	61	49	54	49	62	57
WDVOS-35	57	45	65	53	58	53	66	61
WDVOS-40	59	47	67	55	60	55	68	63
WDVOS-45	62	50	69	57	63	58	70	65

* Noise level in dB(A) - acoustic pressure level at the air outlet side in the free field with taking into consideration the directional coefficient Q=2 and the distance from the fan which are presented in the table.

**Noise level in dB(A) - acoustic pressure level at the air inlet side with taking into consideration the absorption ability of the compartment A=100m², directional coefficient Q=2 and the distance from the air inlet presented in the table.

Presented in the table noise levels concern the fans with the PU universal bases – 30 cm high “without dampers”. Fans with the PTU universal damping bases have the acoustic pressure levels at the air inlet side about **12[dBA]** lower from those mentioned above.

ADDITIONAL INFORMATION

With the WDVOS roof fans we can supply the following additional equipment:

- universal bases
- and additional elements

Fan size	Roof base size		Additional elements			
			Assembly plate	Throttle	Inlet diffuser	Elastic spout
WDVOS-31	PU-4	PUT-4	PM-4	SWD-4	DW-4	KE-4
WDVOS-35	PU-4	PUT-4	PM-4	SWD-4	DW-4	KE-4
WDVOS-40	PU-5	PUT-5	PM-5	SWD-5	DW-5	KE-5
WDVOS-45	PU-5	PUT-5	PM-5	SWD-5	DW-5	KE-5

Elements necessary for assembling the WDVOS fans

- **PU** universal bases
- or **PUT** universal damping bases

Additional elements supplied for the WDVOS

- PM assembly plates;
- SWD self-closing throttle or single-planed throttle operated manually or by the use of servo-motor
- DW inlet diffusers;
- KE elastic spouts.

Technical data of additional fans equipment are presented in the catalogue sheet of universal bases in this catalogue.

AUTOMATICS

Description of operation and fans automatics components selection are presented in the section: VENTILATORS CONTROL AND AUTOMATICS in this catalogue